

50KG. DCP MOBILE FIRE EXTINGUISHER -  
MODEL: NTP 50

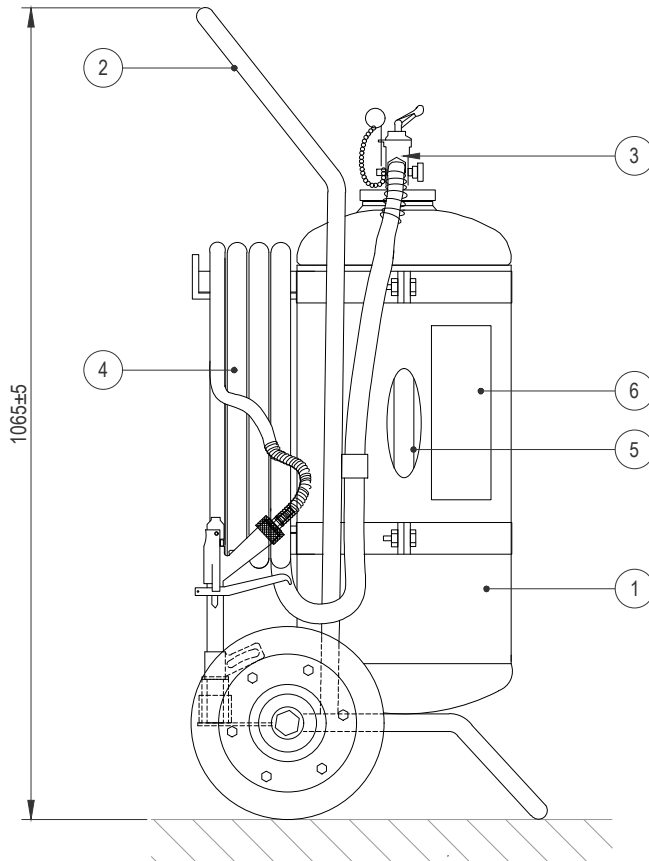
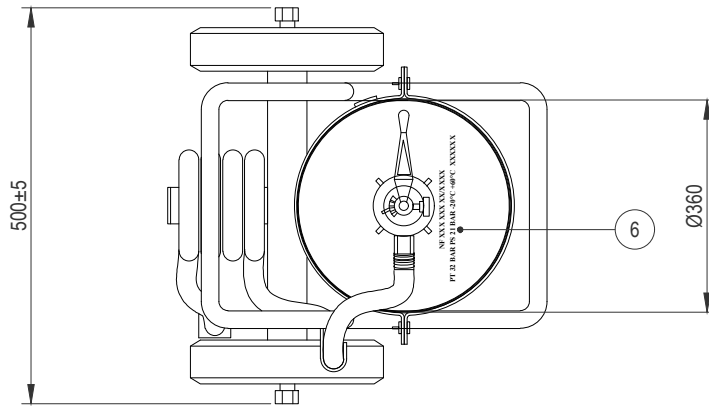

NOTES :-

1. ALL DIMENSIONS ARE IN mm. UNLESS OTHERWISE SPECIFIED

BILL OF MATERIALS

ITEM NO.	DESCRIPTION	MATERIAL	QTY.
1.	CYLINDER ASSEMBLY	EN10025-2 S275 JR	1
2.	TROLLEY FRAME	MILD STEEL	1
3.	ROTARY VALVE	BRASS NI CHROME PLATED	1
4.	DISCHARGE HOSE ASSEMBLY	---	1
5.	DIP TUBE	PVC	1
6.	MARKING & SCREEN PRINTING	---	-

SPECIFICATION:-

CAPACITY	50 KG
AGENT FILLED	50 KG ABC POWDER 85% (MAP 85%)
MODEL	NTP 50
FIRE RATING	IVB
WORKING PRESSURE	18 BAR
CYLINDER TEST PRESSURE	32 BAR
DURATION OF DISCHARGE	47 - 55 SEC
HOSE LENGTH & BORE	5 MTR. & 16 MM
TOTAL WEIGHT	~ 100 KG
TEMPERATURE LIMITS	-20° C TO +60° C
SAFETY RELEASE	24 - 28 BAR
PROPELLANT	NITROGEN OR AIR
COLOUR OF EXTINGUISHER	RED (RAL 3000)

MANUFACTURING STANDARD : BSEN 1866-1 : 2007 & BSEN 1866-2 :2014